



SPECRAIL[®]

FENCES WITHOUT BOUNDARIES

**MAINTENANCE FREE ORNAMENTAL
ALUMINUM FENCE**

Strong and Durable Beauty!



New!!!!

Aluminate[®]

Patented screwless technology
available in most
popular styles

The New Standard of Quality

INTRODUCTION

SPECRAIL, a division of Porcelen, Ltd. CT. LLC, manufactures the most comprehensive choice of aluminum ornamental picket fencing systems to suit the discriminating needs of today’s design professionals. With 50 years of experience in manufacturing and finishing of aluminum construction products, Specrail has enjoyed a leadership role within the industry that has been earned through providing the most styles and grades, while offering function, quality and durability of the highest standard.

Our 180,000 square foot plant located in Hamden, Connecticut includes complete state of the art fabrication and painting facilities. Porcelen, has been a leader in custom finishing since 1957 and offers the versatility of our POWDURA™ powder coating finish on our SPECRAIL fences. We know that every fence or gate we manufacture represents who we are, and so our commitment is not only to our customer’s need, but also to our dedication to quality.

SPECRAIL’s confidence in the quality and longevity of our product allows us to issue a Limited Lifetime Warranty with every fence system sold. This guarantee covers our products against rust, material defects and workmanship, as well as the painted finish against chipping, peeling, or cracking. Whenever you need lasting beauty and protection, SPECRAIL is your best choice.



S-4

“The Mark of Quality . . .



S-1

SPECRAIL Aluminum Fence Features:

- Aluminum Construction - Maintenance free guaranteed!
- Design flexibility: available in eleven standard styles – custom fabrication capabilities
- Colors: commercial/industrial – black, white and bronze
residential/residential-wide – black, white, bronze, hunter green and sandstone
- Complete “one source” manufacturer
- Finest fabrication and finishing facilities in the industry
- Customer responsiveness
- Four grades of fencing: residential (SR), residential-wide (SW), commercial (SC) and industrial (SI)
- Total quality control and service to guarantee customer satisfaction
- Versatility, custom sections and color matching
- POWDURA™ powder tough finish, exceeds AAMA 2604



*...That Makes
An Impression"*

*Imagine the elegance
of a beautiful
maintenance-free
fence to enhance your
property.*



S-1

SPECRAIL manufactures a comprehensive line of standard fences, gates, arbors and handrail. We also offer custom fabrication upon request. We will modify any of our standard styles to accommodate the needs of your design. Specrail's new patented screwless technology – ALUMINATE[®] is available in most popular styles and all grades. A premium ornamental fence system with an attractive screwless panel design.



S-3

Distinctive Elegance *By Design*

S1 - Bennington

This fence is designed to blend into the natural cadence of virtually any landscape. Embracing a traditional fence style, it comes with an accent of spear points across the top.

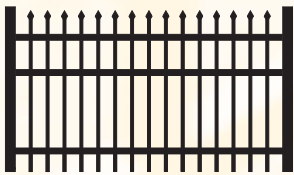

S4 - Saybrook

This classic design with smooth rail top reflects the mood of a late spring evening.

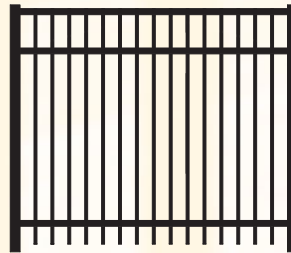

S2 - Berkshire

Like the Bennington, the Berkshire recreates elegant tradition but comes with staggered spear point picket tops.

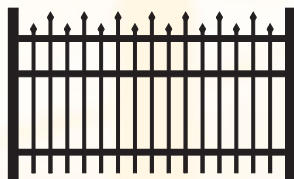

S5 - Newport

Inspired by the life of the ocean, this scallop design with traditional spear points is a statement of grace.

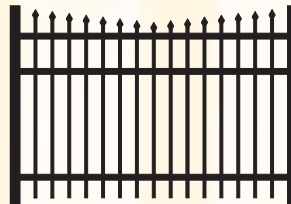

S3 - Essex

With its classic smooth rail top and traditional spear points below, the Essex is designed to meet the most demanding aesthetic needs.

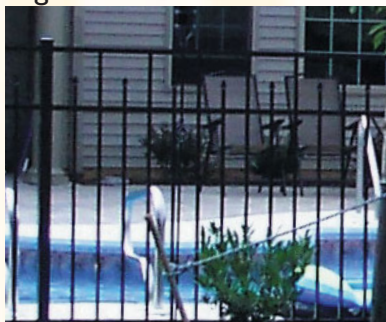
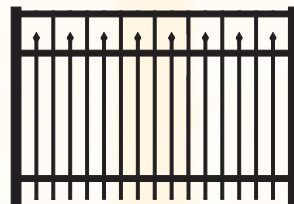

S6 - Citadel

The Citadel's crown design with traditional spear points suggests the power of authority with a subtle ease.



 Indicates available also in our patented ALUMINATE[®] screwless design in all grades.



Emphasis on Detail

S7 - Horizon

This Horizon has a view in mind with its classic design, smooth rail on top and picket spacing of 1½" between pickets is built for harmony in the landscape.

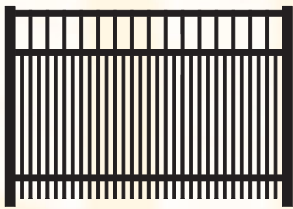

S10 - Derby



The simplicity of this basic two rail smooth top with enclosed pickets is ideal for pool applications and is also excellent for balconies and decks.

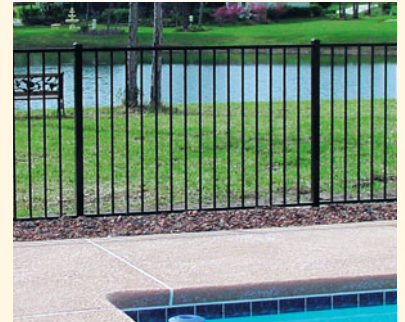
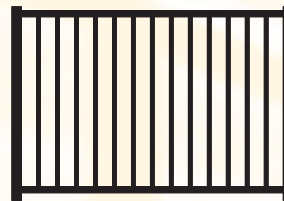

S8 - Falcon

With every other picket thrusting a spear point through the top rail and with 1½" picket spacing, this fence was created to make the vision of your landscape soar

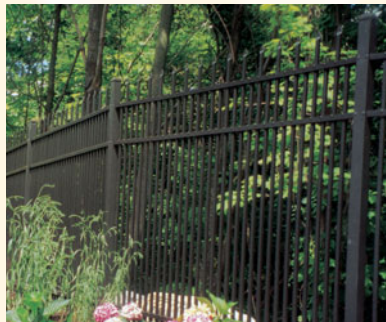
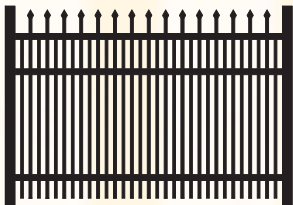

S9 - Storrs



The height of simplicity, this fence with smooth top rail has been modified so that pickets do not extend through the bottom rail.

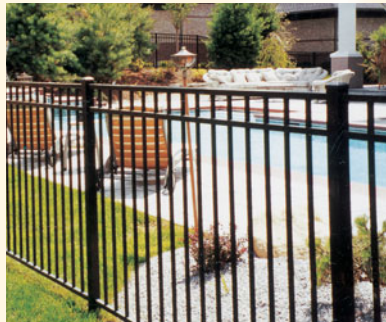
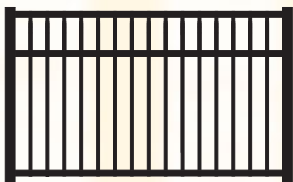

S11 - Privacy Panel

This aluminum board on board privacy design offers a unique alternative to wood or vinyl privacy.

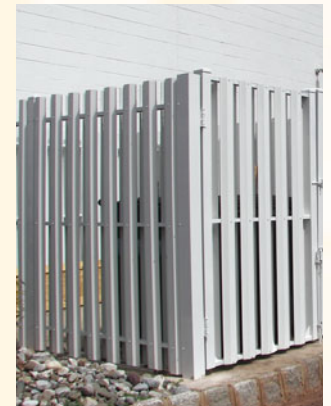
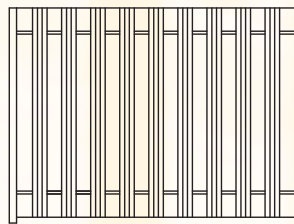

Doggie Panel Modification

Any standard panel maybe modified to incorporate a Doggie Panel in lower third section. This will keep smaller pets in or add detail to any design.

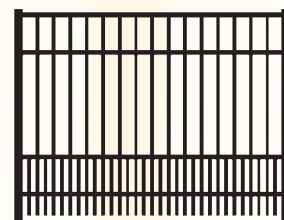

Quality — Specifications

Residential SR

Specrail Residential (SR) aluminum fencing offers a combination of durability, strength and clean appearance, and will keep their attractive finish over a lifetime. Like all Specrail fencing systems, matching gates are available for all of the styles.

The SR system offers a classic appearance to any perimeter and is available in 6' wide panels.

Table of Dimensions

RESIDENTIAL GRADE (SR)	
PICKETS	.625" x .625" x .050"
STRINGERS	1.00" x 1.063" x 1.00"
Side wall	0.060"
Top wall	0.060"
POSTS	2" x 2" x 0.060 wall
GATE POSTS	2" x 2" x 0.125 wall
PICKET SPACING	4.375" o.c.
Spacing between pickets	3.750"
Style SR 7, 8	1.5625"
HEIGHTS AVAILABLE	36", 42", 48", 60", 72"
ALLOY	6105-T5-35,000 PSI
OPTIONAL POST	2.5" x 2.5" industrial post 2.5" x 2.5" x 0.075" wall



SR-2

The Specrail Residential (SR) grade fence system can be applied to a wide range of residential uses. To define residential property lines or enclose a swimming pool, Specrail fence is the perfect choice. It will provide safety, function and beauty for years to come.

Residential Wide SW

Specrail Residential - Wide (SW) aluminum fencing is an innovative design, which combines the light weight of residential with the bold appearance of a heavier system. The result is a fence that truly enhances the appearance of any estate.

The SW system is available in either 6' or 8' wide panels.

Table of Dimensions

RESIDENTIAL GRADE (SW)	
PICKETS	.625" x 1.000" x .050"
STRINGERS	1.00" x 1.063" x 1.00"
Side wall	0.060"
Top wall	0.060"
POSTS	2" x 2" x 0.060" wall
GATE POSTS	2" x 2" x 0.125" wall
PICKET SPACING	5.00" o.c.
Spacing between pickets	4.00"
Style SR 7, 8	1.50"
HEIGHTS AVAILABLE	36", 42", 48", 60", 72"
ALLOY	6105-T5-35,000 PSI
OPTIONAL POST	2.5" x 2.5" industrial post 2.5" x 2.5" x 0.075" wall



SW-1

The Specrail Residential - Wide (SW) grade fence system is an elegant enclosure for estate fencing, swimming pools, golf courses or any residential or light commercial properties.

That Make The Grade



SC-9

Specrail Commercial (SC) fencing system is available in either 6' or 8' wide panels to accommodate any design. The commercial system can be applied to apartment complexes, factories, swimming pools, schools, shopping centers, churches or cemeteries.



SI-1 with Type B Finials

Specifications for the Specrail Industrial (SI) fencing system are most commonly applied to high traffic public areas, industrial complexes, and commercial areas. Other applications may include municipal buildings, schools, churches or apartment complexes.

Commercial SC

Specrail Commercial (SC) fencing system is the perfect complement to any landscape. This unique grade of fencing is ideal for areas where you need the strength of a commercial product with the aesthetic appearance of a narrower picket.

Like all Specrail fencing, the components of this system are constructed of high-strength aluminum alloy, 6105-T5, and this material will not rust.

It is consistently specified by architects, landscape designers, specifiers and municipalities.

The SC system is available in either 6' or 8' wide panels.

Table of Dimensions

COMMERCIAL GRADE (SC)	
PICKETS	.75" x 75" x .050" wall
STRINGERS	1.5" x 1.0" x 1.5"
Side wall	0.090"
Top wall	0.065"
POSTS	2.5" x 2.5" x 0.0750 walls
GATE POSTS	4" x 4" x 0.125 wall
PICKET SPACING	4.312" o.c.
Spacing between pickets	3.562"
Style SR 7, 8	1.437"
HEIGHTS AVAILABLE	36", 42", 48", 60", 72", 84", 96"
ALLOY	6105-T5-35,000 PSI
OPTIONAL POST	2" x 2" x .060" wall 3" x 3" x 0.125" wall

Industrial SI

Specrail Industrial (SI) aluminum fencing system combines its heaviest gauge aluminum extrusions for high visibility and substantial appearance, with aesthetic excellence. The finished product will beautify property lines while creating a deterrent to illegal entry.

The SI system is also available in either 6' or 8' wide panels.

Table of Dimensions

INDUSTRIAL GRADE (SI)	
PICKETS	1" x 1" x .065"
STRINGERS	1.625" x 1.250" x 1.625"
Side wall	0.100"
Top wall	0.070"
POSTS	2.5" x 2.5" x 0.075" wall
GATE POSTS	4" x 4" x 0.125" wall
PICKET SPACING	5.00" o.c.
Spacing between pickets	4"
Style SR 7, 8	1.5"
HEIGHTS AVAILABLE	36", 42", 48", 60", 72", 84", 96"
ALLOY	6105-T5-35,000 PSI
OPTIONAL POST	3" x 3" x 0.125" wall 4" x 4" x 0.125" wall

Quality — Gates Built to Last . . .

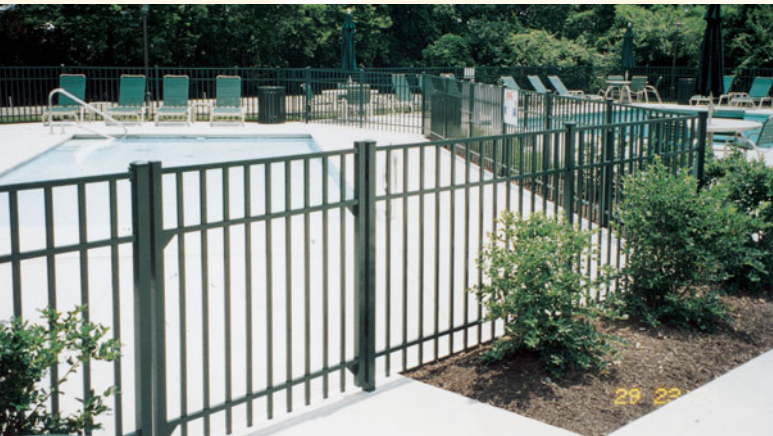

S-4

SPECRAIL gates are available to match all styles and grades. Gates are the most important component of any fencing project. After years of engineering and field research, Specrail has developed structurally sound gates that set us apart from the competition.

Our exclusive “punch-tru” design with welded corner gussets on our heavy walled aluminum gate frame is the strongest gate frame on the market.



SR-1 with SR-6 Walk Gate



We offer the Locinox™ with built-in dead bolt or the Magna-Latch™, to insure that your gates have a positive method of locking.



... Built To Your Requirements.

SPECRAIL can custom build the gate you need to complete your entry system.



Custom, S-7, Graded Gate



Greenwich Estate, S-9, with Security Screen

SPECRAIL gates are built to be attractive and above all functional. All walk gates are furnished with self-closing hinges with adjustable tension.

Regal[™] Series Designer Gates . . .

Our Regal Designer Series estate gates offers beautifully arched top gates, which adds elegance and flare to any entrance.



Greenwich Estate, S-2, with Type A Finials, Custom Panel

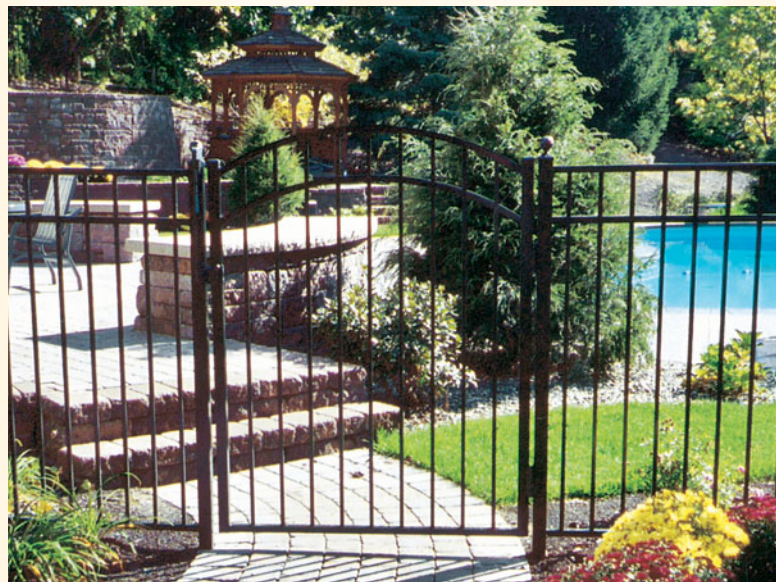

Greenwich Estate, S-9

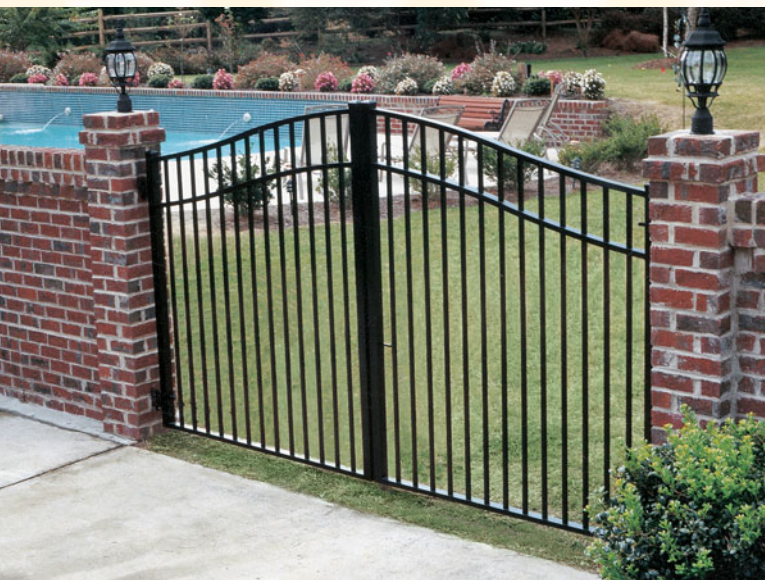

Woodbridge Estate, S-9



Woodbridge Estate, S-1, with Type B Finials

All welded construction, these gates are custom fitted to your opening and can be mounted to any type of column or post.

. . . as Unique as You Are!

Quality . . .



Custom Woodbridge Estate with, Stars, Type B Finials and Doggie Panel



Woodbridge Estate, S-1, with Gold Type B Finials and Gold Rings

*. . . That Adds
Style & Strength*

Each gate is a statement in itself, however, they become even more attractive with the addition of SPECRAIL's decorative castings.

Construction Details

- All Welded Construction
 - POWDURA™ Polyester Coating
 - Heavy Wall 6105-T5 Alloy
 - Aluminum Cast Ornaments
- Rails 2" x 1" channel
Vertical Frame 2" x 2" sq
Pickets 5/8" sq; 3/4" sq, 1" sq



Greenwich Estate, S-1, with Large Scroll

Elegant and exquisite, SPECRAIL's Regal Designer ornamental estate entrance gates will add beauty and security to your property. Fabricated as single welding technology and high tension strength aluminum.

SPECURITY[™] Cantilever Gates . . .



S9

SPECURITY[™] Cantilever Gates

Constructed of heavy walled aluminum utilizing enclosed roller trucks for smooth operation year-after-year.

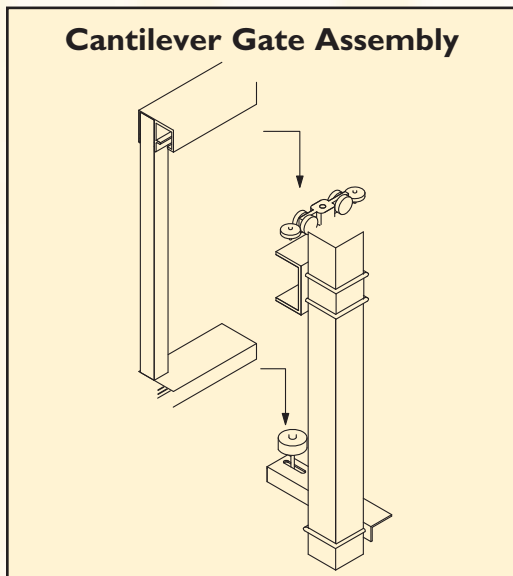

S-10

- Durable and strong
- Fully adjustable
- Permanent good looks
- Engineered for high performance

Quality . . . That Adds Security

SPECURITY™ Hardware

- Standard 4-wheel truck roller
- Lower guide rollers (eliminates lateral movement)
- Factory lubricated sealed bearings

STRENGTH

- One piece overhead truck and frame
- All-welded construction
- Stainless steel aircraft cable bracing

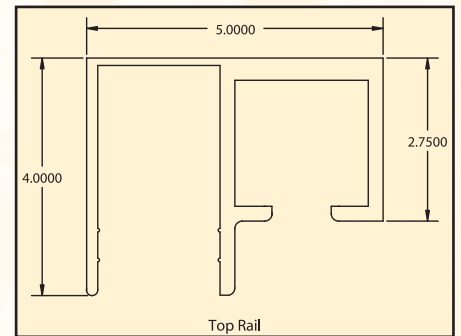
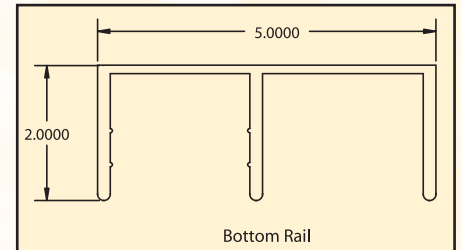
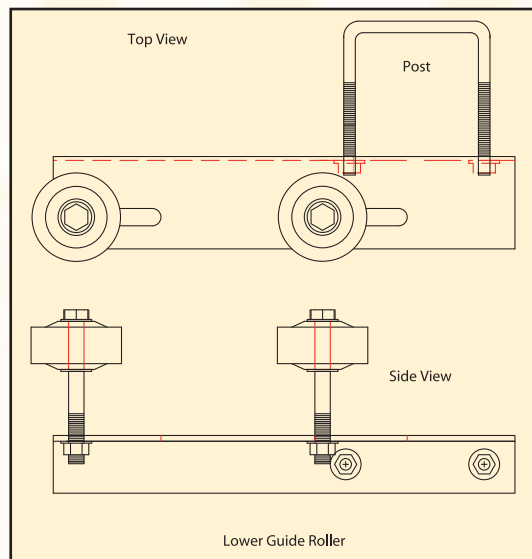
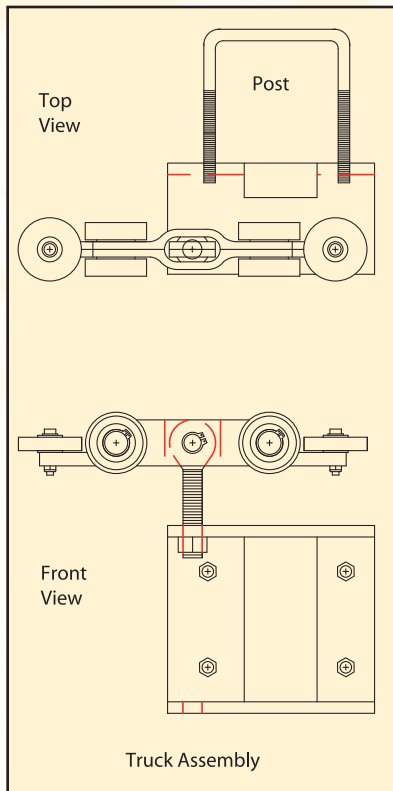

Quality . . .

Garden Arbors



Type A - Arlington



Arbor Type B - Burlington



Manchester II

SPECRAIL's arbors are ideal for beautifying and enhancing the appearance of your property. Beautiful designs and fine craftsmanship, fabricated from the same high quality maintenance-free aluminum as our fence systems.

- No painting or staining
- Won't peel, flake or rust . . . EVER!
- Impervious to termites
- Warranty - limited lifetime
- Available in colors!
- Three standard designs (Arlington, Burlington & Manchester)

... Aluminum Handrail Systems

SPECRAIL's aluminum railing systems are designed to offer you strength and elegance. Built to provide maximum safety with style and colors.

System Features & Benefits

Bellaire: ¾" picket, 1½" breadloaf top rail, 6' assembled panels

Avon: 1" picket, 2½" breadloaf top rail, 6', 8' & 10' assembled panels

Bridgeport: 1" picket, 2½" breadloaf top rail, 6', 8' & 10' assembled panels with concealed screws

Canton: versatile component system that allows you the use of a myriad of infill options from glass, expanded metal, woven wire, welded wire and more. 2½" breadloaf top rail.

Posts: 3" sq. or 4" sq

Height: 36" & 42" standard

POWDURA™ super durable coating, exceeds AAMA 2604

Standard colors: black, white or bronze.

Custom color matching upon request.



Avon



Bridgeport



Canton Glass Infill

Quality . . .

Accessories to add



Ball Caps

Reminiscent of turn-of-the-century estate fences, these ball caps are the finishing touch for any of SPECRAIL's line of fences.



Finials

- **Type A.** The quad finial is SPECRAIL's decorative option for any fence you select. Cast with a rust-free color coating.
- **Type B.** With its medieval shape, the triad finial tops any fence with the style of tradition.



... That Touch of Elegance!



Rings

SPECRAIL's rings are created to soften the linear face of any fence.

Accessories can be finished to either match or accent your SPECRAIL fence.



Diamonds and X's

SPECRAIL's diamonds and X's add a modern whimsical detail to any fence.



Large & Small Scrolls

- These large scrolls are designed to add a touch of elegance to the fence of your choice.
- Unique in look and design, SPECRAIL's small scrolls can be combined with the large scroll option for a lasting impression.

Quality . . .



S-1

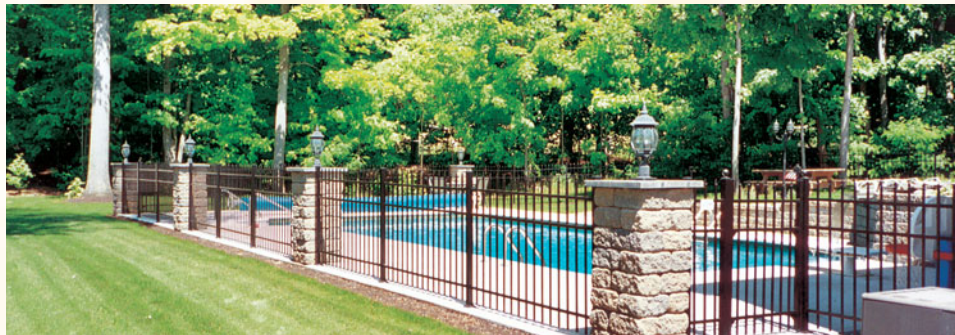

S-1



S-4

...Elegance



S-1

Security ...



S-1, Modified



Custom Woodbridge Estate, S-1

Unique ...

SPECRAIL's fences are coated with an environmentally approved POWDURA™ polyester powder coating, a super durable powder-tough finish that exceeds AAMA 2604 specifications.

All residential fences are available in black, white, bronze, sandstone and hunter green. Industrial commercial fences are available in black, white and bronze. Custom color matching is available.

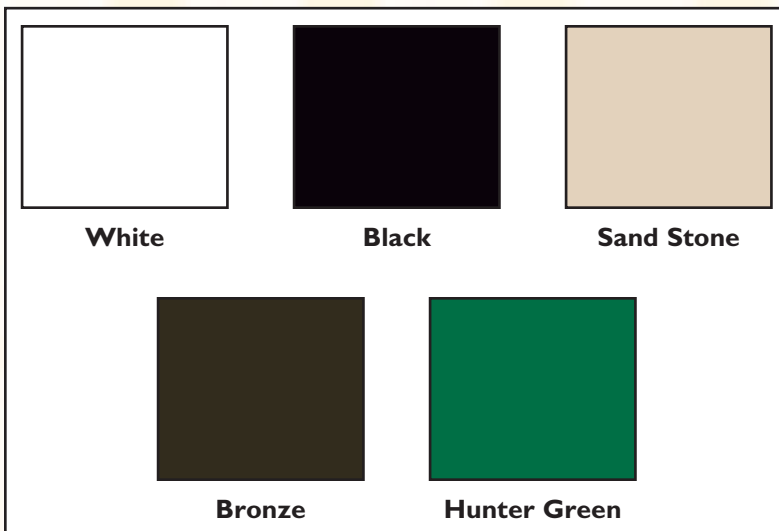

Color swatches are not true representation. Color sample chips available upon request.

SECTION 02825 - ORNAMENTAL ALUMINUM FENCES AND GATES**PART 1 - GENERAL****1.01 Work Included**

The contractor shall provide labor, materials and all necessary accessory items for the installation of the ornamental aluminum fence system specified herein at (specified project location)

1.02 Related Work

Section 022 — Earthwork
Section 030 — Concrete

1.03 System Description

The manufacturer shall apply a total ornamental aluminum fencing system of the style, strength, and color defined herein. The system shall be a total package including all components, pickets, posts, stringers, gates and hardware as required.

1.04 Quality Assurance

The contractors shall provide laborers and supervisors who are thoroughly familiar with the type of construction involved and the materials specified.

1.05 References

AAMA 603.8 — Performance requirements & testing procedures for pigmented organic coatings.
ASTM B221 — Specifications for aluminum alloy extruded bars, shapes and tubes.

1.06 Submittal

The manufacturer's literature shall be submitted prior to installation to confirm compliance with all requirements for materials specified in this section.

1.07 Delivery, Storage, and Handling

A. Fence panels, gates, posts and accessories shall be delivered to the construction site in packed cartons.
B. Each package shall be identified and shall bear the name of manufacturer.
C. Store all materials in a secure and dry area.

PART 2 - PRODUCTS**2.01 Manufacturer**

The aluminum fencing systems shall be manufactured by Specrail, 333 Welton Street, Hamden, CT 06517. The fence shall be [specify from applicable options on page 4 thru 5 style, (specify height from tables on pages 6 and 7 and color on page 19)].

2.02 Materials

A. Aluminum Extrusions: All components shall be made of 6105-t5 in accordance with ASTM B221.

B. Fasteners: All screws shall be 302 stainless self-drilling head. All screws shall be painted to match the finish of fence.

C. Accessories: Aluminum castings shall be used for all post caps, wall brackets, scrolls, finials and other miscellaneous hardware. Hinges and latches shall be fabricated from aluminum extrusions with stainless steel springs.

2.03 Finish

The fence shall be coated with POWDURA™, an environmentally approved, premium polyester powder coating which exceeds AAMA 2604. Application of POWDURA shall be electrostatic spray. Curing shall be at a temperature of 375°F to 400°F.

2.04 Fabrication

A. Stringers*, (horizontal rails) shall be punched to allow pickets to pass through the top of the rail. The number of stringers shall vary with the style, height and strength as determined by manufacturer.

B. Pickets*, shall be fastened to stringers mechanically with stainless steel TEK screws on one side of the stringer only or secured with concealed retention bar.

C. Posts*, shall be prepunched to allow the stringers to slide in and be attached with stainless steel TEK or attach by use of stainless spring button clip. Cast aluminum post caps shall be affixed to all posts.

D. Gates shall be fabricated using the same components as for the complete fencing system. Walk gates shall have adjustable self-closing hinges and will be self-latching.
*(Specify style and dimensions from tables on page 3 though 5.)

PART 3 - EXECUTION**3.01 Preparation**

Prepare the grade and remove surface irregularities, if any, which may cause interference with the installation of aluminum fence.

3.02 Installation

A. Set fence posts at 6'0" on center maximum, set gate posts for gate openings specified in the construction drawings.

B. Insert stringers ends into prepunched posts and fasten with TEK screws or attach by use of stainless spring button clip.

C. Center and align posts. Place concrete around posts, and vibrate or tamp for consolidation. Recheck vertical and top alignment of posts, and make necessary corrections.

D. Install gates plumb, level and secure for full opening without interference. For double gates, install drop rod. Adjust all hardware for smooth operation.

3.03 Cleaning

Contractor shall clean jobsite of excess materials; post hole excavations shall be scattered uniformly away from posts. Clean aluminum fence with mild household detergent and clean water rinse well. Mortar should be removed from exposed posts using a 10% solution of muriatic acid followed immediately by several rinses with clean water.